



ABOX 300 UM

Escape sign luminaire according to DIN EN 60598-1/2-22 and DIN EN 1838. Modern IP54 escape sign luminaire made of anodized aluminum for wall, ceiling and bracket mounting. For wall mounting, installation is via the rear panel of the luminaire, for ceiling and bracket mounting via an adapter supplied with the luminaire. In addition, the luminaire has light emission windows facing downwards. The luminaire price includes one ceiling adapter, one rear panel and one pictogram set - arrow left/right/down/blind (recognition distance 30m). The luminaire is equipped with a 3 Watt LED strip.



Technical specifications

Luminaire type	Luminaire for central battery systems	Self contained luminaire
Illuminant		3 W LED-bar
Visibility distance		30 m
Connecting terminals	3 x 2,5 mm ² for double assignment	
Colour	white aluminum (silver)	
Material	Aluminum	
Mounting type	Wall-/ceiling mounting, wall bracket mounting	
Dimensions (W x H x D)	DM 333 x 200 x 80 mm WM 333 x 181 x 81 mm ALM 354 x 181 x 80 mm	
Protection class	IP54	
Safety class	I	
IK Safety class	IK03	
Light current (Net)	350 lm	
Luminous flux Emergency (DC) / mains	-	20% / 100% (1h) 20% / 100% (3h) 10% / 100% (8h)
Power consumption	6,0 VA	
Battery current input	19 mA	-
Rated operating time Battery operation	-	1h / 3h / 8h
Voltage supply	230V 50/60Hz; 220V DC +25/-20%	230V 50/60Hz
NiMh-battery	-	4,8V 0,8Ah (1h) 4,8V 0,8Ah (3h) 4,8V 0,8Ah (8h)
Temperature range	-10°C to +40°C	-
Non-maintained mode	-	0°C to +35°C
Maintained mode	-	-5°C to +30°C
optional		
Multi-switch and monitoring module	DALI ELC MSÜ3 SET009 SET010	SELF CHECK SAFELOG Line SAFELOG Wireless

Accessories

Chain assembly set
Central pendulum - Plastic
Cable assembly set
Wire guard
Universal cover plate

Ceiling mounting

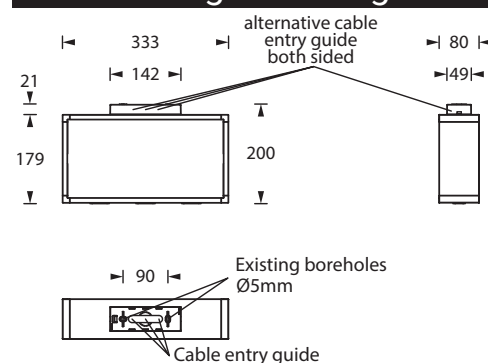

Wall mounting

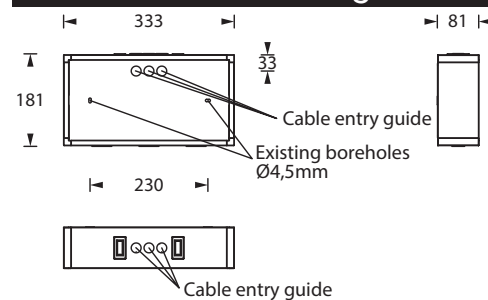

Bracket mounting

