



S-LINE 200 BEL

Extremely lean polycarbonate housing in an appealing design for wall or ceiling mounting. Easy to handle locking mechanism without screws. Optionally: Recessed mounting with recessed ceiling frame. Optionally available for wide area or escape route lighting.

The luminaire is equipped with a 2 Watt LED-bar.

Technical specifications

Connecting terminals	2 x 2,5 mm ² for double assignment
Casing/colour	Polycarbonate / white (light cover clear)
Type of assembly	Ceiling or wall mounting
Dimensions (W x H x D)	265 x 69 x 37 mm
Protection class	IP43
Safety class	II



	■ Luminaires for central battery systems	■ Self contained luminaires
Illuminant	2W LED-bar	2W LED-bar
Light current	240lm	240lm (net)
Rated operating time 1h	-	240lm (emergency)
Rated operating time 3h	-	105lm (emergency)
Luminous flux		
Emergency (DC)/mains 1h	-	100% / 100%
Emergency (DC)/mains 3h	-	45% / 100%
Power consumption	5,5VA	5,5VA
Battery current input	14mA	-
Voltage supply	230V 50/60Hz / 220V DC +25/-20%	230V 50/60Hz
NiMh-Akku 1h	-	4,8V 0,8Ah
NiMh-Akku 3h	-	4,8V 0,8Ah
Temperature range	-10°C to +40°C	-
non-maintained mode	-	-0°C to +35°C
maintained mode	-	-5°C to +30°C
optional:		
Multi-switch and monitoring module	MSÜ3, SET009, SET010	-
Self monitoring	-	SELF CHECK
Central monitoring	-	SAFELOG

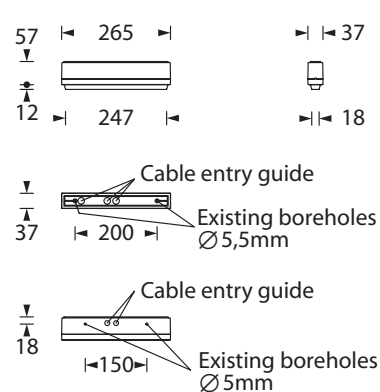

Accessories

Chain assembly set	
Wire guard	
Cable assembly set	
Ceiling mounting frame	



optional: Recessed ceiling frame

Lighting datas and tables of luminaire distances (E = 1,25 lx)

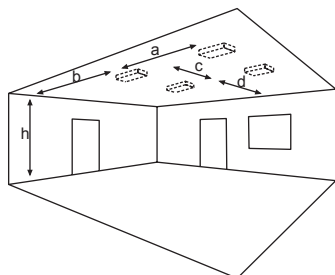

Ceiling mounting

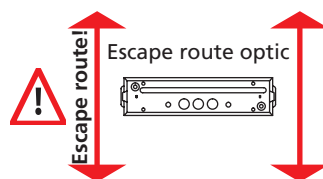

Mounting direction

Luminaires for central battery systems wide area lighting

Distance table for plane emergency routes / distance data in meters

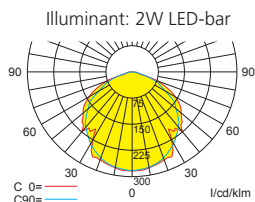

Luminous flux emergency (DC)/mains: 240lm / 240lm

h	2,50	3,00	3,50	4,00	4,50	5,00	5,50	6,00	6,50	7,00	7,50	8,00	8,50	9,00	9,50	10,00	10,50	11,00	12,00
a	6,80	7,50	7,80	8,60	8,90	9,20	9,40	9,60	9,70	9,80	-	-	-	-	-	-	-	-	-
b	1,80	1,90	1,90	1,90	1,80	1,70	1,60	1,40	1,20	0,70	-	-	-	-	-	-	-	-	-
c	7,40	7,80	8,40	8,90	9,30	9,50	9,80	10,00	10,00	10,00	-	-	-	-	-	-	-	-	-
d	1,90	1,90	2,00	2,00	1,70	1,60	1,60	1,60	1,20	0,70	-	-	-	-	-	-	-	-	-

Self contained luminaires wide area lighting

Distance table for plane emergency routes / distance data in meters

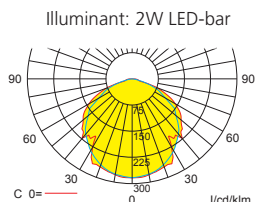

Luminous flux emergency/mains: 240lm/240lm - **Rated operating time: 1h**

h	2,50	3,00	3,50	4,00	4,50	5,00	5,50	6,00	6,50	7,00	7,50	8,00	8,50	9,00	9,50	10,00	10,50	11,00	12,00
a	6,80	7,50	7,80	8,60	8,90	9,20	9,40	9,60	9,70	9,80	-	-	-	-	-	-	-	-	-
b	1,80	1,90	1,90	1,90	1,80	1,70	1,60	1,40	1,20	0,70	-	-	-	-	-	-	-	-	-
c	7,40	7,80	8,40	8,90	9,30	9,50	9,80	10,00	10,00	10,00	-	-	-	-	-	-	-	-	-
d	1,90	1,90	2,00	2,00	1,70	1,60	1,60	1,60	1,20	0,70	-	-	-	-	-	-	-	-	-

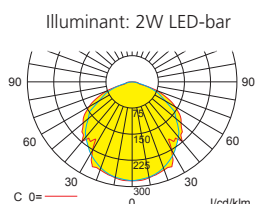

Luminous flux emergency/mains: 105lm/240lm - **Rated operating time: 3h**

h	2,50	3,00	3,50	4,00	4,50	5,00	5,50	6,00	6,50	7,00	7,50	8,00	8,50	9,00	9,50	10,00	10,50	11,00	12,00
a	5,30	5,90	6,20	6,10	6,50	-	-	-	-	-	-	-	-	-	-	-	-	-	-
b	1,20	1,20	1,10	0,90	0,60	-	-	-	-	-	-	-	-	-	-	-	-	-	-
c	5,80	6,10	6,40	6,60	6,70	-	-	-	-	-	-	-	-	-	-	-	-	-	-
d	1,30	1,10	1,10	1,00	0,60	-	-	-	-	-	-	-	-	-	-	-	-	-	-

Luminaires for central battery systems escape route optic

Distance table for plane emergency routes / distance data in meters

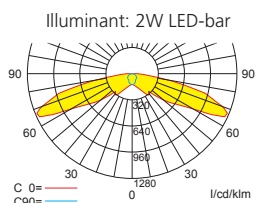

Luminous flux emergency (DC)/mains: 240lm / 240lm

h	2,50	3,00	3,50	4,00	4,50	5,00	5,50	6,00	6,50	7,00	7,50	8,00	8,50	9,00	9,50	10,00	10,50	11,00	12,00
a	-	-	-	-	-	-	-	-	-	-	-	-	-	-	-	-	-	-	-
b	-	-	-	-	-	-	-	-	-	-	-	-	-	-	-	-	-	-	-
c	17,40	19,60	20,30	21,90	23,40	23,50	17,70	14,00	11,50	7,00	-	-	-	-	-	-	-	-	-
d	7,20	8,20	8,60	8,90	8,40	4,30	4,30	4,00	3,50	3,00	-	-	-	-	-	-	-	-	-

Self contained luminaires escape route optic

Distance table for plane emergency routes / distance data in meters

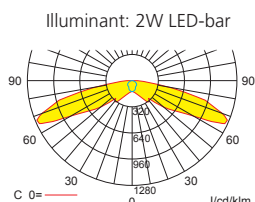

Luminous flux emergency/mains: 240lm/240lm - **Rated operating time: 1h**

h	2,50	3,00	3,50	4,00	4,50	5,00	5,50	6,00	6,50	7,00	7,50	8,00	8,50	9,00	9,50	10,00	10,50	11,00	12,00
a	-	-	-	-	-	-	-	-	-	-	-	-	-	-	-	-	-	-	-
b	-	-	-	-	-	-	-	-	-	-	-	-	-	-	-	-	-	-	-
c	17,40	19,60	20,30	21,90	23,40	23,50	17,70	14,00	11,50	7,00	-	-	-	-	-	-	-	-	-
d	7,20	8,20	8,60	8,90	8,40	4,30	4,30	4,00	3,50	3,00	-	-	-	-	-	-	-	-	-

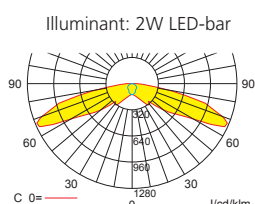

Luminous flux emergency/mains: 105lm/240lm - **Rated operating time: 3h**

h	2,50	3,00	3,50	4,00	4,50	5,00	5,50	6,00	6,50	7,00	7,50	8,00	8,50	9,00	9,50	10,00	10,50	11,00	12,00
a	-	-	-	-	-	-	-	-	-	-	-	-	-	-	-	-	-	-	-
b	-	-	-	-	-	-	-	-	-	-	-	-	-	-	-	-	-	-	-
c	14,20	15,50	13,60	9,50	-	-	-	-	-	-	-	-	-	-	-	-	-	-	-
d	5,80	5,00	3,00	2,50	-	-	-	-	-	-	-	-	-	-	-	-	-	-	-